



Service Crimpers

Compact, universal and powerful.



Content



Page 08-09
SL 3



Page 10-11
SH 2



Page 12-13
HM 200



Page 14-15
SC 3 | SC 4



Page 16-17
SH 4



Page 18-19
SH 7



Page 20-21
SC 6



Page 22-23
SH 6



Page 24-25
SH 10 i | SH 10 i XL



Page 26-27
SC 12 i



Page 28
PUM | PUU



Service Crimpers



Greaseless

- Slide bearings on the crimp tool improve efficiency up to 20%, reduce friction and help keep the tool free of contaminants
- No greasing improves cleanliness of machine
- Prolongs the machine's lifetime
- Maximum productivity with very low maintenance costs
- No risk of prematurely damaging the crimping head
- End product can be used in sanitary applications without cleaning
- 20% more capability for crimping stronger or more difficult couplings versus our competition's equivalent crimpers
- Consistently accurate crimp result



Universal

- For all types of hoses and fittings



Ecoline

- Value driven solution for less frequent use



Ergonomic

- Free access for fast loading of the tool
- Compact design fits in any workshop and is ideal for on-site service
- Large opening travel for easy crimping of elbow fittings without removing the dies



Environment friendly

- Energy efficient and durable

Overview of press types

SC = Cylinder pressing Tool



Front view

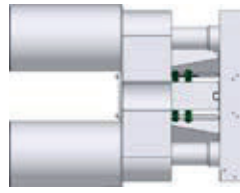

Side view

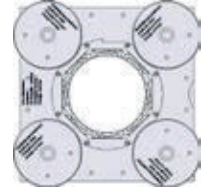

Rear view

SH = Hollow Piston pressing Tool

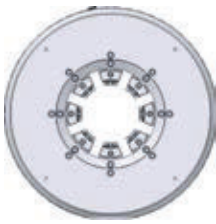

Front view



Side view



Rear view

HM = Yoke pressing Tool

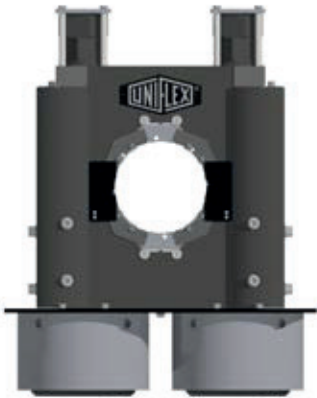

Front view



Side view

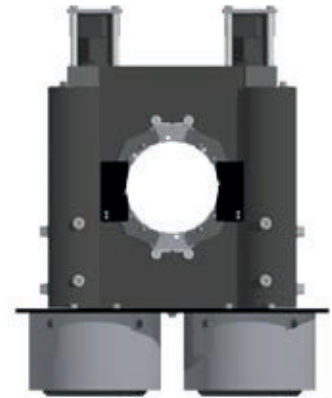

Rear view

Crimping Tool Types

	SC*	SH	HM
No greasing	★★★	★★★	★★★
Low maintenance	★★★	★★	★★★
Compact	★★	★★★	★★
Light weight	★★	★★★	★
Accessibility of the workpiece	★★★	★★	★★★
Dirt-sensitivity	★★★	★	★★★
Sustainable	★★★	★★	★★★
Good value	★★	★★★	★★★
Well suited for	Workshop	Mobile	Continuous Operation
Factory warranty in years	3	2	3

* Including HM 200

The CRIMP MANAGER APP by UNIFLEX Modern Support for Mobile Hose Production



Innovative App Management for Online Data Exchange between Hose Crimper and Central Administration

With the Crimp Manager App by UNIFLEX, you always have the necessary crimping table up to date and complete on your smartphone or tablet – both online and offline. Thanks to modern, innovative software, crimping processes can be saved as favorites and sent directly to the hose press via Bluetooth. After the crimping process, all relevant data is automatically recorded and transmitted to your server via the internet, ensuring efficient and seamless documentation.



Design Leaflet

Define your own individual design.

Define functions individually
for the customer.



Keep full control over your production data

The Crimp Manager by UNIFLEX enables the recording and analysis of all crimping processes. Detailed evaluations and customized reports by region, customer, or product can be easily generated on your computer using the data collected through the app. This allows for precise order forecasts, demand analyses, and consumption data, optimizing your processes efficiently.

Security

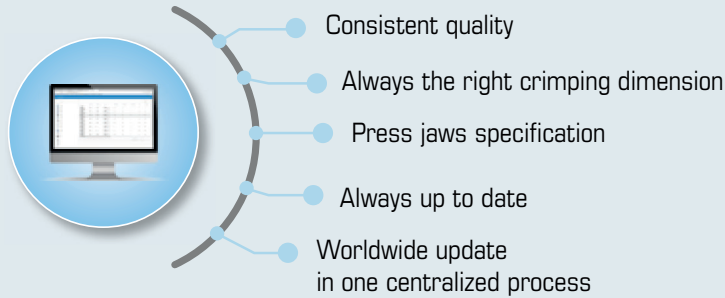

Efficiency

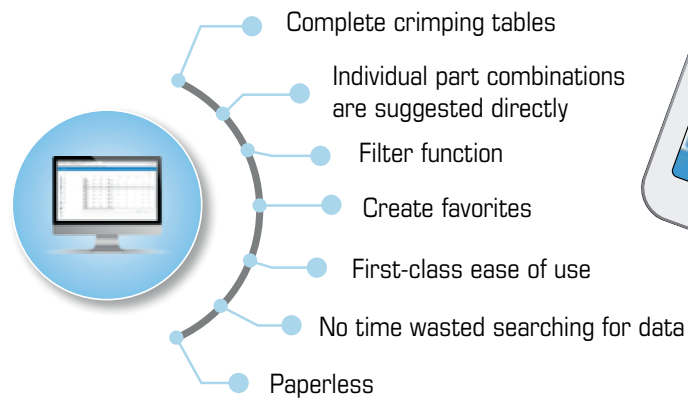

Logging

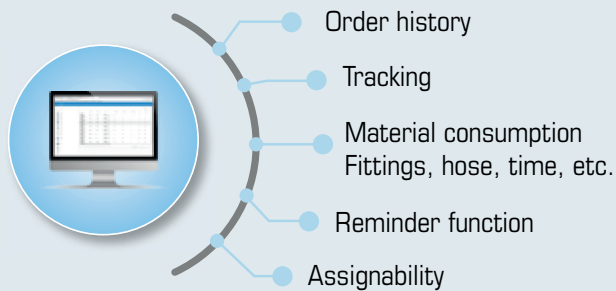

Analysis





Next-generation crimper for low pressure hose assemblies. Two-in-one solution with integrated die sets O5 and O15 for DN 03-16. With the SL 3-16 M.3, UNIFLEX innovates the existing crimper: Two integrated die sets in one tool. No more lost time changing the die. Simply switch the control lever and you are already crimping the other size. No risk of losing dies, no dirty hands, no "time lost". With the built-in handle, you can easily carry it anywhere.

SL 3-32 M and SL 3-75 complete the range with large opening travel up to 3".



SL 3-16 M.3



SL 3-32 M



SL 3-75_A (Power unit not included. Available as accessory.)



SL 3-16 M.3

SL 3-32 M

SL 3-75

Technical Data	SL 3-16 M.3	SL 3-32 M	SL 3-75
Crimp force (kN/Ton)	30/3	200/20	500/50
Opening travel (mm/inch)	+31.7/+1.24	+36.7/+1.44	+55/+2.16
Industrial	5/8**	1 1/4**	3**
Opening without dies (mm/inch)	38.6 / 1.52	88 / 3.46	115 / 4.52
Type of dies Ø	150: 6.9 and 14.9 mm	263.2	239
Master dies length (mm/inch)	10/0.39	68/2.68	75/2.95
L x W x H (mm)	340 x 143 x 780	216 x 165 x 348	420 x 520 x 550
Weight (kg)	20	28	88
Accessories			
Power unit	-	-	✓

Type of dies		Type of dies	
	263.2		239
Ø mm	mm	Ø mm	mm
6.8	40	6.8	50
9	75	9	50
12	75	10	50
14	75	12	50
17	75	14	60
20	75	16	60
24	75	17	60
28	75	19	60
32	75	20	60
36	75	22	60
40	75	24	60
44	75	26	75
47	75	28	75
		30	75
		31	75
		32	75
		34	75
		36	75
		38	75
		39	75
		40	75
		44	75
		47	75
		50	75
		54	75
		57***	75
		62***	75

* According to the fitting. ** With master dies. *** Not suitable for QDC 239.5.

Description



2 sets of dies integrated, no die set change necessary! (Only for SL3-16M)



PUU Power unit



Must workshops and mobile service teams do without the power and reliability of large stationary crimpers? UNIFLEX's answer is a definite "no". Our compact, multi-purpose workshop crimpers prove that the advantages of the legendary slide bearing technology can also be used in light-weight, inexpensive equipment that will fit into almost any vehicle and workshop.

The SH 2 series models offer an optimal force-to-weight ratio of 1" 4 SP at a weight of 29 kg, a large opening stroke up to 22 mm (0.87") and a maximum pressing range up to 63 mm (2.48").

New in the range is the SH 2 XL with a larger opening while maintaining full press force. Also new: the QDC grip for quick die changes – compatible with all SH 2 tools, including the new SH 2 XL.



SH 2 XL



SH 2 M H2



SH 2 A



SH 2 M Ecoline

SH 2 M H2

SH 2 P

SH 2 A

SH 2 LA

SH 2 XL

Technical Data	SH 2 M Ecoline	SH 2 M H2	SH 2 P	SH 2 A	SH 2 LA	SH 2 XL
Crimp force (kN/Ton)	900/90	900/90	900/90	900/90	450/45	900/90
No grease: 20% less friction	✓	✓	✓	✓	✓	✓
4-spiral + 1-pc fittings*	1¼"	1¼"	1¼"	1¼"	¾"	1¼"
4-spiral + 2-pc fittings*	1"	1"	1"	1"	⅝"	1"
Industry hose	1¼"	1¼"	1¼"	1¼"	1¼"	1¼"
90° Elbows	1"	1"	1"	1"	1"	1"
Max. Crimp range** (mm/inch)	63 / 2.48	63 / 2.48	63 / 2.48	63 / 2.48	63 / 2.48	63 / 2.48
Opening (mm/inch)	+22 / +0.87	+22 / +0.87	+22 / +0.87	+22 / +0.87	+22 / +0.87	+27 / +1.06
Opening without dies (mm/inch)	77 / 3.03	77 / 3.03	77 / 3.03	77 / 3.03	77 / 3.03	82 / 3.22
Master dies length (mm/inch)	75 / 2.95	75 / 2.95	75 / 2.95	75 / 2.95	75 / 2.95	75 / 2.95
Type of dies	263.2	263.2	263.2	263.2	263.2	263.2
Press path (mm)	8	8	8	8	8	12
Speed (mm/sec)						
Close	-	-	0.9	5.8	2.4	2.7
Crimp	-	-	0.9	0.6	0.2	2.7
Drive	Manual	Manual	Pneumatic ***	1~VAC	1~VAC	12 or 24 V DC or 1 Ph 110/220 V, 50/60 Hz.DC oder 1 Ph 110/220 V, 50/60 Hz.
Oil	0.75 l	0.75 l	2 l	1.5 l	1.5 l	1.5 l
L x W x H (mm)	216 x 165 x 348	500 x 420 x 440	380 x 400 x 310	450 x 450 x 350	450 x 450 x 450	540 x 716 x 562 without power unit
Weight (kg)	29	32	33	41	56	80

Type of dies	
263.2-xx-Øxx	
Ø mm	mm
6.8	40
9	75
12	75
14	75
17	75
20	75
24	75
28	75
32	75
36	75
40****	75
44****	75
47****	75

* According to the fitting. ** With master dies. *** 7 bar/98 psi. **** Not suitable for QDC 263.3.

Packages page 28 / Accessories and options page 50

Description



On SH 2 models, an optical signal is given when the crimp measure is reached. The electric and pneumatic variants have an automatic stop function.



Telescopic hand-lever available. Included with SH 2 M machines.



New standard by SH 2 MH and SH 2 M Ecoline with special pump. The low pressure delivery volume is around three times higher than the standard: 32/3 cc instead of 11/3 cc



PUM 0.8/3.2-700 bar. The mobile high pressure unit achieves 700 bar: a real magic box! Not for SH 2 LA and SH 2 XL.



QDC 263.3



SH = Hollow piston press tool



As the unrivaled classic in the 1" field, with its narrow, innovative construction, high level of user friendliness, versatility and long service life, the HM 200 sets the unbeatable standard for quality and cost effectiveness. Its compact construction allows for ergonomic working. The use of different die sets allows pressing of all types of fittings, and the proven greaseless slide bearing technology reduces maintenance costs. The Ecoline model is hydraulically controlled and has a separate tank to save space in workshops.



HM 200



HM 200 Ecoline



PUU (optional)



HM 200

HM 200 Ecoline

Technical Data	HM 200	HM 200 Ecoline
Crimp force (kN/Ton)	1,300/130	1,300/130
No grease: 20% less friction	✓	✓
Control	Control A	Control A
4-spiral + 1-pc fittings*	1½"	1½"
4-spiral + 2-pc fittings*	1¼"	1¼"
4/6-spiral + 2-pc fittings*	1"	1"
Industry hose	2"	2"
90° Elbows	1½"	1½"
Max. Crimp range (mm/inch)	70 / 2.76	70 / 2.76
Opening (mm/inch)	+30 / +1.18	+30 / +1.18
Opening without dies (mm/inch)	100 / 3.94	100 / 3.94
Master dies length (mm/inch)	75 / 2.95	75 / 2.95
Type of dies	239	239
Press path (mm)	8	8
Speed (mm/sec)		
Close / Crimp / Open	3.5 / 3.5 / 5.9	3.5 / 3.5 / 5.9
Noise level	69 dBA	69 dBA
Drive	3 kW 3~VAC	3 kW 3~VAC
Oil	40 l	40 l (DC 4 l)
L x W x H (mm)	800 x 530 x 630	420 x 535 x 520
Power Unit L x W x H (mm)	-	300 x 450 x 560
Weight (kg)	140	92 (without power unit), 130 (with die package)
Options		
12 VDC/24 VDC	-	✓
1~VAC	✓	2.2 kW
Control C.2/IPC	✓	-

Type of dies	
Ø mm	mm
 239	
6.8	50
9	50
10	50
12	50
14	60
16	60
17	60
19	60
20	60
22	60
24	60
26	75
28	75
30	75
31	75
32	75
34	75
36	75
38	75
39	75
40	75
44	75
47	75
50	75
54	75
57**	75
62**	75

* According to the fitting. ** Not suitable for GDC 239.5.

Packages page 28 / Accessories and options page 50

Description



The micrometer allows you to easily set the crimping diameter.



The large opening stroke allows you to pass 90° fittings without changing the crimp dies.



The 12 VDC/24 VDC units offer space- and weight-saving application options, e.g. for fitting service trucks.
L x W x H (mm):
441 x 291 x 296; 21 kg



A box with master dies is available in a package.



For mobile applications the HM 200 is ideally suitable.

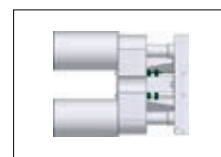

SC = Press tool with Cylinder



Due to their narrow and innovative construction, high level of user friendliness and long service life, the SC 3 and SC 4 set new standards for quality and cost effectiveness. Their compact construction allows for ergonomic working. The use of long master dies allows you to crimp 90° elbow fittings up to 1 ¼" for SC 3 and 1 ½" for SC 4, with the tried and tested greaseless slide bearing technology, which reduces maintenance costs and increases the product quality.

Because the 4-cylinder technology is particularly resistant to contamination from press dust, UNIFLEX offers a 3-year warranty for the SC 3 and SC 4 series.



SC 4 Ecoline C.2



SC 3 Ecoline



SC 4 Ecoline



SC 3 Ecoline

SC 4 Ecoline

SC 4 Ecoline C.2

Technical Data	SC 3 Ecoline	SC 4 Ecoline	SC 4 Ecoline C.2
Crimp force (kN/Ton)	1,200/120	1,800/180	1,800/180
No grease: 20% less friction	✓	✓	✓
Control	Control A	Control A	Control C.2
4-spiral + 1-pc fittings*	1½"	2"	2"
4-spiral + 2-pc fittings*	1¼"	2"	2"
4/6-spiral + 2-pc fittings*	1"	1½"	1½"
Industry hose	2"	2"	2"
90° Elbows	1½"	1½"	1½"
Max. Crimp range (mm/inch)	70 / 2.76	70 / 2.76	70 / 2.76
Opening (mm/inch)	+35 / +1.38	+35 / +1.38	+35 / +1.38
Opening without dies (mm/inch)	105 / 4.13	105 / 4.13	105 / 4.13
Master dies length (mm/inch)	100 / 3.94	100 / 3.94	100 / 3.94
Type of dies	239-xx-Ø	239 - xx	239 - xx
Press path (mm)	12	12	12
Speed (mm/sec)			
Close	4.0	2.7	2.7
Crimp	4.0	2.7	2.7
Open	6.5	4.7	4.7
Noise level	69 dBA	69 dBA	69 dBA
Drive	3 kW 3~VAC	3 kW 3~VAC	3 kW 3~VAC
Oil	35 l	35 l	35 l
L x W x H (mm)	592 x 545 x 672	592 x 545 x 672	720 x 600 x 672
Weight (kg)	150	160	203
Options			
12 VDC/24 VDC	✓	✓	-
1~VAC	✓	✓	✓
Control C.2/IPC	✓	-	✓

Type of dies	
Ø mm	mm
	239-xx-Ø-yy
6.8	65
9	65
10	65
12	65
14	65
16	65
17	65
19	65
20	65
22	65
24	65
26	65
28	80
30	80
31	80
32	80
34	80
36	80
38	80
39	80
40	80
44	80
47	100
50	100
54	100
57**	100
62**	100

* According to the fitting. ** Not suitable for GDC 239.5. Packages page 28 / Accessories and options page 50

Description

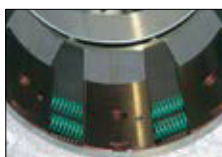

The SC 3- and SC 4-series is fitted with the clean slide bearing technology.



The SC 3- and SC 4-series can be used to crimp short 90° elbow fittings with a long drop. This is impossible for other conventional service-machines.



With the double pin connection, it is possible to crimp on the front and rear sides.



The 12 VDC/24 VDC units offer space- and weight-saving application options, e.g. for fitting service trucks.
L x W x H (mm):
441 x 291 x 296; 21 kg



SC = Press tool with Cylinder



Due to its narrow and innovative construction, high level of user friendliness and long service life, the SH 4 sets new standards for quality and cost effectiveness. Its very compact design despite a high pressing force and a weight of only 110 kg allows ergonomic operation even on mobile jobs. The long base jaws enable pressing up to 1½" 4 SP, the proven greaseless slide bearing technology reduces maintenance costs and increases production quality.



SH 4 Ecoline



SH 4 Mobileline

SH 4 C.2



SH 4 Ecoline

SH 4 Mobileline

Technical Data	SH 4 Ecoline	SH 4 Mobileline
Crimp force (kN/Ton)	1,800/180	1,800/180
No grease: 20% less friction	✓	✓
Control	Control A	Control A
4-spiral + 1-pc fittings*	2"	2"
4-spiral + 2-pc fittings*	2"	2"
4/6-spiral + 2-pc fittings*	1½" (6-sp 1¼")	1½" (6-sp 1¼")
Industry hose	2"	2"
90° Elbows	1¼"	1¼"
Max. Crimp range (mm/inch)	70 / 2.76	70 / 2.76
Opening (mm/inch)	+27 / +1.06	+27 / +1.06
Opening without dies (mm/inch)	97 / 3.82	97 / 3.82
Master dies length (mm/inch)	110 / 4.33	110 / 4.33
Type of dies	239-xx-Ø	239-xx-Ø
Press path (mm)	12	12
Speed (mm/sec)		
Close	2.0	3
Crimp	2.0	1
Open	7.6	10
Noise level	69 dBA	69 dBA
Drive	3 kW 3~VAC	1,8 kW 1~VAC (new with double pump)
Oil	35 l	4 l
L x W x H (mm)	600 x 550 x 630	430 x 370 x 440
Weight (kg)	150	110 (without power unit)
Options		
12 VDC/24 VDC	-	✓
1~VAC	✓	✓
Control C.2/IPC	✓	-
PB 239-MD-Ø 70 (Closing pin for master dies SH 4)	✓	✓

Type of dies



239-xx-Ø-yy

Ø mm	mm
6.8	65
9	65
10	65
12	65
14	65
16	65
17	65
19	65
20	65
22	65
24	65
26	65
28	80
30	80
31	80
32	80
34	80
36	80
38	80
39	80
40	80
44	80
47	100
50	100
54	100
57**	100
62**	100

* According to the fitting. ** Not suitable for GDC 239.5. Packages page 28 / Accessories and options page 50

Description



The 12 VDC/24 VDC units offer space- and weight-saving application options, e.g. for fitting service trucks. L x W x H (mm): 441 x 291 x 296; 21 kg



PB 239-MD-Ø 70 Closing Pin for Master dies SH 4. (Ø 70 mm)



For mobile applications the SH 4 Mobileline is also ideally suitable.



SH = Hollow piston press tool



With over 50 years on the market, it is still the strongest press with the best power-to-weight ratio (2" / 77 kg). The SH 7 sets standards for quality and cost-effectiveness due to its narrow, innovative design, high user-friendliness, versatility, and long service life. Its low weight and compact design make the SH 7 perfect for both stationary and mobile use up to 2 inches, as well as for use as a service or reserve press for quick deployment. The proven, lubrication-free sliding bearing technology with a quick-change system reduces maintenance costs, extends service life, and increases precision.



SH 7



Quick insertion of the jaws



SH 7 with closed dies and QDC



SH 7

SH 7 S

Technical Data	SH 7	SH 7 S
Crimp force (kN/Ton)	2,400/240	3,200/320
No grease: 20% less friction	✓	✓
Control	Control A	Control A
4/6-spiral + 1-pc fittings*	2"	2"
4-spiral + 2-pc fittings*	2"	2"
4/6-spiral + interlock*	1½"	1½"
Industry hose	2"	2"
90° Elbows	1½"	1½"
Max. Crimp range (mm/inch)	82 / 3.23	82 / 3.23
Opening (mm/inch)	+24 / +0.94	+24 / +0.94
Opening without dies (mm/inch)	110 / 4.33	110 / 4.33
Master dies length (mm/inch)	90 / 3.54	90 / 3.54
Type of dies	239 - xx/265	239 - xx/265
Press path (mm)	8	8
Speed (mm/sec)		
Close	Manuell	Manuell
Crimp	0.42	0.42
Open	Manuell	Manuell
Noise level	70 dBA	70 dBA
Drive	0.75 kW 3~VAC	0.75 kW 3~VAC
Oil	2.3 l	2.3 l
L x W x H (mm)	430 x 367 x 682	430 x 367 x 682
Options (kg)	77	77
Options		
12 VDC/24 VDC	✓	✓
1 Phase	✓	✓

Type of dies	
	239-xx-Ø-yy
Ø mm	mm
6.8	65
9	65
10	65
12	65
14	65
16	65
17	65
19	65
20	65
22	65
24	65
26	65
28	80
30	80
31	80
32	80
34	80
36	80
38	80
39	80
40	80
44	80
47	100
50	100
54	100
57**	100
62**	100

Type of dies	
	265
Ø mm	mm
54	100
57	100
62	100
67	100
71	100
74	100

* According to the fitting. ** Not suitable for QDC 239.5. Packages page 28 / Accessories and options page 50

Description



The micrometer allows you to easily set the crimping dimensions.



The machine is pre-positioned manually.



The lightest mobile 2"-service crimping machine. Also available in 12 VDC/24 VDC.



265.2 Turntable



SH = Hollow piston press tool



With its slim, innovative design, high user-friendliness, versatility and long service life, the SC 6 series with its 4-cylinder technology sets standards for quality and economy. Its very compact design, despite the large opening travel, allows ergonomic working. The long base jaws enable the SC 6 to crimp short 90° fittings up to 2" 4 SP, and the SC 6 S up to 2" R 15. The proven greaseless slide bearing technology reduces maintenance costs, extends service life and increases accuracy. Because the 4-cylinder technology is particularly resistant to contamination from press scale, UNIFLEX offers a 3-year warranty for the SC 6 and SC 6 S series.



SC 6 C.2



SC 6 Ecoline C.2



SC 6 Ecoline



SC 6 Ecoline SC 6 SC 6 S Ecoline SC 6 S

Technical Data	SC 6 Ecoline	SC 6	SC 6 S Ecoline	SC 6 S
Crimp force (kN/Ton)	2,000/200	2,000/200	2,800/280	2,800/280
No grease: 20% less friction	✓	✓	✓	✓
Control	Control A	Control C.2	Control A	Control C.2
4/6-spiral + 1-pc fittings*	2"	2"	2"	2"
4-spiral + 2-pc fittings*	2"	2"	2"	2"
4/6-spiral + interlock*	1½"	1½"	2"	2"
Industry hose	3"	3"	3"	3"
90° Elbows	2"	2"	2"	2"
Crimp range (mm/inch)	102 / 4.02	102 / 4.02	102 / 4.02	102 / 4.02
Opening (mm/inch)	+45 / +1.77	+45 / +1.77	+45 / +1.77	+45 / +1.77
Opening without dies (mm/inch)	147 / 5.78	147 / 5.78	147 / 5.78	147 / 5.78
Master dies length (mm/inch)	110 / 4.33	110 / 4.33	110 / 4.33	110 / 4.33
Type of dies	239 - xx/266 **	239 - xx/266 **	239 - xx/266 **	239 - xx/266 **
Press path (mm)	17	17	17	17
Speed (mm/sec)				
Close	4.9	9.7	3.0	6
Crimp	2.3	2.2	1.4	1.4
Open	8.2	16	5.3	13.3
Noise level	69 dBA	67 dBA	69 dBA	67 dBA
Drive	4 kW 3~VAC	4 kW 3~VAC	4 kW 3~VAC	4 kW 3~VAC
Oil	50 l	70 l	50 l	70 l
L x W x H (mm)	700 x 600 x 735	745 x 600 x 1360	700 x 600 x 735	745 x 600 x 1,360
Weight (kg)	275	375	315	415
Options				
12 VDC/24 VDC	✓	-	✓	-
1 Phase	✓	✓	✓	✓
Control C.2/IPC	✓	✓	✓	✓

Type of dies		
239-xx-Ø-yy 266		
Ø mm	mm	mm
6.8	65	
9	65	
10	65	
12	65	
14	65	
16	65	
17	65	
19	65	
20	65	
22	65	
24	65	
26	65	
28	80	
30	80	
31	80	
32	80	
34	80	
36	80	
38	80	
39	80	
40	80	
44	80	
47	100	
50	100	
54	100	110
57***	100	110
62***	100	110
67		110
71		110
74		110
78		110
84		110
86		110
92		110
94		110

* According to the fitting. ** Without intermediate dies. *** Not suitable for GDC 239.5. Packages page 28 / Accessories and options page 50

Description



The S 6 series can be used to crimp short 90° elbow fittings with a long drop. This is impossible for other conventional machines.

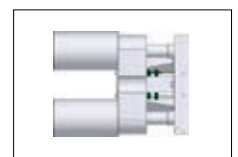

SC = Press tool with Cylinder



Due to their narrow and innovative construction, high level of user friendliness and long service life, the SH 6 series set new standards for quality and cost effectiveness. Their large opening +43 mm (+ 1.69") and light weight 172 kg make it the perfect machine for mobile application up to 2" 4 SP and 3" return line.

The use of long master dies allows you to crimp 90° elbow fittings up to 2" with the tried and tested greaseless slide bearing technology, which reduces maintenance costs and increases the product quality.



SH 6 Ecoline



SH 6 Mobileline
(ideal for mobile applications)

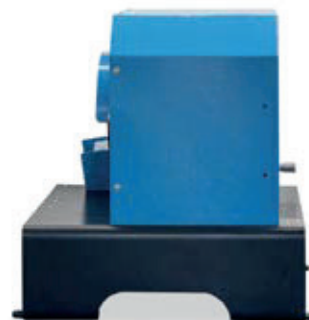

SH 6 Mobileline (side view)



SH 6 Ecoline

SH 6 Mobileline

SH 6 S Ecoline

SH 6 S Mobileline

Technical Data	SH 6 Ecoline	SH 6 Mobileline	SH 6 S Ecoline	SH 6 S Mobileline	Type of dies																																																																																																												
Crimp force (kN/Ton)	2,400/240	2,400/240	2,800/280	2,800/280	 239-xx-Ø-yy 266 <table border="1"> <thead> <tr> <th>Ø mm</th> <th>mm</th> <th>mm</th> </tr> </thead> <tbody> <tr><td>6.8</td><td>65</td><td></td></tr> <tr><td>9</td><td>65</td><td></td></tr> <tr><td>10</td><td>65</td><td></td></tr> <tr><td>12</td><td>65</td><td></td></tr> <tr><td>14</td><td>65</td><td></td></tr> <tr><td>16</td><td>65</td><td></td></tr> <tr><td>17</td><td>65</td><td></td></tr> <tr><td>19</td><td>65</td><td></td></tr> <tr><td>20</td><td>65</td><td></td></tr> <tr><td>22</td><td>65</td><td></td></tr> <tr><td>24</td><td>65</td><td></td></tr> <tr><td>26</td><td>65</td><td></td></tr> <tr><td>28</td><td>80</td><td></td></tr> <tr><td>30</td><td>80</td><td></td></tr> <tr><td>31</td><td>80</td><td></td></tr> <tr><td>32</td><td>80</td><td></td></tr> <tr><td>34</td><td>80</td><td></td></tr> <tr><td>36</td><td>80</td><td></td></tr> <tr><td>38</td><td>80</td><td></td></tr> <tr><td>39</td><td>80</td><td></td></tr> <tr><td>40</td><td>80</td><td></td></tr> <tr><td>44</td><td>80</td><td></td></tr> <tr><td>47</td><td>100</td><td></td></tr> <tr><td>50</td><td>100</td><td></td></tr> <tr><td>54</td><td>100</td><td></td></tr> <tr><td>57***</td><td>100</td><td></td></tr> <tr><td>62***</td><td>100</td><td>110</td></tr> <tr><td>67</td><td></td><td>110</td></tr> <tr><td>71</td><td></td><td>110</td></tr> <tr><td>74</td><td></td><td>110</td></tr> <tr><td>78</td><td></td><td>110</td></tr> <tr><td>84</td><td></td><td>110</td></tr> <tr><td>86</td><td></td><td>110</td></tr> <tr><td>92</td><td></td><td>110</td></tr> <tr><td>94</td><td></td><td>110</td></tr> </tbody> </table>	Ø mm	mm	mm	6.8	65		9	65		10	65		12	65		14	65		16	65		17	65		19	65		20	65		22	65		24	65		26	65		28	80		30	80		31	80		32	80		34	80		36	80		38	80		39	80		40	80		44	80		47	100		50	100		54	100		57***	100		62***	100	110	67		110	71		110	74		110	78		110	84		110	86		110	92		110	94		110
Ø mm	mm	mm																																																																																																															
6.8	65																																																																																																																
9	65																																																																																																																
10	65																																																																																																																
12	65																																																																																																																
14	65																																																																																																																
16	65																																																																																																																
17	65																																																																																																																
19	65																																																																																																																
20	65																																																																																																																
22	65																																																																																																																
24	65																																																																																																																
26	65																																																																																																																
28	80																																																																																																																
30	80																																																																																																																
31	80																																																																																																																
32	80																																																																																																																
34	80																																																																																																																
36	80																																																																																																																
38	80																																																																																																																
39	80																																																																																																																
40	80																																																																																																																
44	80																																																																																																																
47	100																																																																																																																
50	100																																																																																																																
54	100																																																																																																																
57***	100																																																																																																																
62***	100	110																																																																																																															
67		110																																																																																																															
71		110																																																																																																															
74		110																																																																																																															
78		110																																																																																																															
84		110																																																																																																															
86		110																																																																																																															
92		110																																																																																																															
94		110																																																																																																															
No grease: 20% less friction	✓	✓	✓	✓																																																																																																													
Control	Control A	Control A	Control A	Control A																																																																																																													
4/6-spiral + 1-pc fittings*	2"	2"	2"	2"																																																																																																													
4-spiral + 2-pc fittings*	2"	2"	2"	2"																																																																																																													
4/6-spiral + interlock*	1½"	1½"	2"	2"																																																																																																													
Industry hose	3"	3"	3"	3"																																																																																																													
90° Elbows	2"	2"	2"	2"																																																																																																													
Crimp range (mm/inch)	102 / 4.02	102 / 4.02	102 / 4.02	102 / 4.02																																																																																																													
Opening (mm/inch)	+41 / +1.69	+41 / +1.69	+45 / +1.69	+45 / +1.69																																																																																																													
Opening without dies (mm/inch)	145 / 5.71	145 / 5.71	145 / 5.71	145 / 5.71																																																																																																													
Master dies length (mm/inch)	110 / 4.33	110 / 4.33	110 / 4.33	110 / 4.33																																																																																																													
Type of dies	239 - xx/266 **	239 - xx/266 **	239 - xx/266 **	239 - xx/266 **																																																																																																													
Press path (mm)	12	12	20	20																																																																																																													
Speed (mm/sec)																																																																																																																	
Close	30/1.8	10/0.5	30/1.8	10/0.5																																																																																																													
Crimp	1.8	0.5	1.8	0.5																																																																																																													
Open	10.6/30	3/30	10.6/30	3/30																																																																																																													
Noise level	69 dBA	69 dBA	69 dBA	69 dBA																																																																																																													
Drive	3 kW 3~VAC	1.8 kW 1~VAC (new with double pump)	3 kW 3~VAC	1.8 kW 1~VAC (new with double pump)																																																																																																													
Oil	35 l	4 l	35 l	4 l																																																																																																													
L x W x H (mm)	600 x 550 x 750	505 x 430 x 490	709 x 613 x 691	505 x 621 x 573																																																																																																													
Weight (kg)	196	172	206	182																																																																																																													
Options																																																																																																																	
12 VDC/24 VDC	-	✓	-	✓																																																																																																													
1 Phase	✓	✓	✓	✓																																																																																																													
Control C.2/IPC	✓	-	✓	-																																																																																																													

* According to the fitting. ** Intermediate dies not required. *** Not suitable for GDC 239.5. Packages page 28 / Accessories and options page 50

Description



The 12 VDC/24 VDC units offer space- and weight-saving application options, e.g. for fitting service trucks.

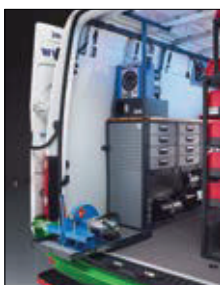

For mobile applications the SH 6 Mobileline is also ideally suitable.



SH = Hollow piston press tool



Due to their narrow and innovative construction, high level of user friendliness and long service life, the SH 10 i and SH 10 i XL set new standards for quality and cost effectiveness. Their large opening, + 45 mm (+ 1.77") for SH i 10 and +61 mm (+ 2.40") for S 10 i XL, fits industrial hoses with large flanges.

The use of long master dies allows you to crimp 90° elbow fittings up to 2" with the tried and tested greaseless slide bearing technology, which reduces maintenance costs and increases the product quality.



SH 10 i XL IPC



SH 10 i Ecoline



SH 10 i C.2



SH 10 i Ecoline

SH 10 i

SH 10 i XL Ecoline

SH 10 i XL

Technical Data	SH 10 i Ecoline	SH 10 i	SH 10 i XL Ecoline	SH 10 i XL
Crimp force (kN / Ton)	2,800/280	2,800/280	2,800/280	2,800/280
No grease: 20% less friction	✓	✓	✓	✓
Control	Control A	Control C.2	Control A	Control C.2
4/6-spiral + 1-pc fittings*	2"	2"	2"	2"
4-spiral + 2-pc fittings*	2"	2"	2"	2"
4/6-spiral + interlock*	2"	2"	2"	2"
Industry hose	4"	4"	4"	4"
90° Elbows	2"	2"	2"	2"
Max. Crimp range (mm/inch)	145 / 5.70	145 / 5.70	145 / 5.70	145 / 5.70
Opening (mm/inch)	+45 / +1.77	+45 / +1.77	+61 / +2.40	+61 / +2.40
Opening without dies (mm/inch)	190 / 7.48	190 / 7.48	200 / 7.87	200 / 7.87
Master dies length (mm/inch)	126 / 4.96	126 / 4.96	126 / 4.96	126 / 4.96
Type of dies	239 - xx/237 L **	239 - xx/237 L **	239-xx-Ø/237 L **	239-xx-Ø/237 L **
Press path (mm)	17	17	17	17
Speed (mm/sec)				
Close	4.8	6.1	30/6.0	30/6.0
Crimp	2.3	1.7	1.4	1.4
Open	7.9	10.3	30/17	30/17
Noise level	70 dBA	67 dBA	67 dBA	70 dBA
Drive	4 kW 3~VAC	5.5 kW 3~VAC	4 kW 3~VAC	5.5 kW 3~VAC
Oil	50 l	70 l	50 l	70 l
L x W x H (mm)	700 x 600 x 845	690 x 600 x 1.400	700 x 600 x 845	690 x 600 x 1,400
Weight (kg)	372	390	390	430
Options				
Control C.2/IPC	✓	✓	✓	✓
1 Phase	✓	✓	✓	✓
12 VDC/24 VDC	✓	-	✓	-

Type of dies		Type of dies	
Ø mm	mm	Ø mm	mm
239-xx-Ø-yy		237 L	
6.8	65	54	118
9	65	57	118
10	65	62	118
12	65	67	118
14	65	71	118
16	65	74	118
17	65	78	118
19	65	84	118
20	65	86	118
22	65	90	118
24	65	96	118
26	65	103	118
28	80	106	126
30	80	111	126
31	80	116	126
32	80	121	126
34	80	126	126
36	80	131	126
38	80	135	126
39	80	137	126
40	80		
44	80		
47	100		
50	100		
54	100		
57***	100		
62***	100		

* According to the fitting. ** Intermediate dies not required. *** Not suitable for GDC 239.5. Packages page 28 / Accessories and options page 50

Description

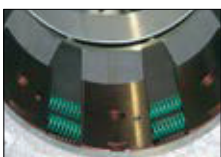

The SH 10 and SH 10 XL-series is fitted with the clean slide bearing technology.

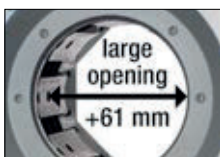

The SH 10 XL offers a large opening travel of up to 61 mm.



ICC – Industrial (hose) Crimp Calculator (only with C.2 and IPC controller)

Automatically calculate your crimp diameter directly from your hose and fitting measurement based on compression. Includes the official agreed, tested and approved industrial hose crimp calculator/Interface with fitting and ferrule data from Mario, PT, Campbell and Dixon.



SH = Hollow piston press tool



With a 370-ton crimping force, the SC 12 i is the most powerful workshop crimper for R15 industrial hoses up to 3" and high pressure hoses up to 1". With its large opening and a maximum crimping range of up to 139 mm (5.47"), the SC 12 i also crimps 4" Camlock industrial fittings and even 90° fittings with ease.

The compact design allows direct access from all sides, which is particularly important when crimping short workpieces. Three versions of the SC 12 i are available: with a micrometer, Control C.2 or IPC. Like all UNIFLEX crimpers, the SC 12 i features the legendary UNIFLEX slide bearing technology for maximum cleanliness and consistent operations as well as low maintenance requirements and a full 3-year manufacturer's warranty.



SC 12 i IPC



SC 12 i IPC

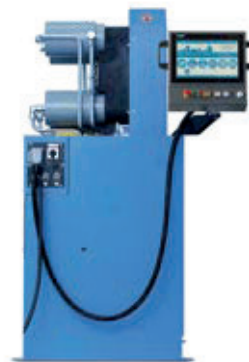



SC 12 i IPC



SC 12 i A

SC 12 i C.2

Technical Data	SC 12 i A	SC 12 i C.2	Type of dies		Type of dies	
Crimp force (kN/Ton)	3,700/370	3,700/370	 239-xx-β-yy		 237 L	
No grease: 20% less friction	✓	✓	∅ mm	mm	∅ mm	mm
Control	Control A	Control C.2	6.8	65	54	118
4/6-spiral + 1-pc fittings*	3"	3"	9	65	57	118
4/6-spiral + 2-pc fittings*	3"	3"	10	65	62	118
4/6-spiral + interlock*	3"	3"	12	65	67	118
Industry hose	4"	4"	14	65	71	118
90° Elbows	2"	2"	16	65	74	118
Max. Crimp range (mm/inch)	145 / 5.71	145 / 5.71	17	65	78	118
Opening (mm/inch)	+61 / +2.40	+61 / +2.40	19	65	84	118
Opening without dies (mm/inch)	206 / 8.11	206 / 8.11	20	65	86	118
Master dies length (mm/inch)	126 / 4.96	126 / 4.96	22	65	90	118
Type of dies**	239 / 237L	239 / 237L	24	65	96	118
Press path (mm)	17	17	26	65	103	118
Speed (mm/sec)			28	80	106	126
Close	30/4.9	30/4.9	30	80	111	126
Crimp	1.4	1.4	31	80	116	126
Open	30/8.6	30/8.6	32	80	121	126
Noise level	< 70 dBA	< 70 dBA	34	80	126	126
Drive	5.5 kW 3~VAC	5.5 kW 3~VAC	36	80	131	126
Oil	85 L	85 L	38	80	135	126
L x W x H (mm)	690 x 750 x 1,470	690 x 750 x 1,470	39	80	137	126
Weight (kg)	553	555	40	80		
			44	80		
			47	100		
			50	100		
			54	100		
			57***	100		
			62***	100		
Options						
12 VDC/24 VDC	✓	-				
1 Phase	✓	-				
Control C.2/IPC	✓	✓				

* According to the fitting. ** Intermediate dies not required. *** Not suitable for GDC 239.5.

Packages page 28 / Accessories and options page 50

Description



The micrometer allows you to set crimp dimensions to set. (Control A)



The SC 12 series can be used to crimp short 90° elbow fittings with a long drop. This is impossible for other conventional machines.



ICC – Industrial (hose) Crimp Calculator (only with C.2 and IPC controller)

Automatically calculate your crimp diameter directly from your hose and fitting measurement based on compression. Includes the official agreed, tested and approved industrial hose crimp calculator/Interface with fitting and ferrule data from Mario, PT, Campbell and Dixon.

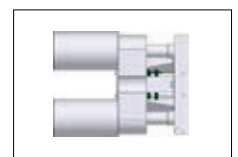

SC = Press tool with Cylinder

Press Die Sets

	QDS 263 B	QDS 263 B-8-RAL 7021	QDC 263	
SH 2 M Ecoline				Package: Machine + PB Ø 14, 17, 20, 24 + QDS 26X B
SH 2 M H2, SH 2 P, SH 2 A, SH 2 LA				Package: Machine + PB Ø 14, 17, 20, 24, 28, 32, 40 + QDS 26X B
	QDS 239 B	QDC 239.5		
HM 200, SC 3, SH 4				Package: Machine + PB Ø 17, 20, 24, 28, 32, 40, 44, 47, 50 + QDS 239 B + QDC 239.5
SC 4				Package: Machine + PB Ø 17, 20, 24, 28, 32, 36, 40, 44, 47, 54, 62 + QDS 239 B + QDC 239.5
SH 7, SC 6, SH 6, SH 6 S				Package: Machine + PB 17, 20, 24, 28, 32, 40, 44, 50, 57, 71 + 265.239 L + QDS 239 B + QDC 239.5
SH 10 i, SH 10 i XL				Package: Machine + PB Ø 17, 20, 24, 28, 32, 40, 44, 50, 57, 71 + 237.239.2L2 + QDS 239 B + QDC 239.5
SC 12 i				Package: Machine + PB Ø 17, 20, 24, 28, 32, 40, 44, 50, 57, 71 + 237.239.2L2 + QDS 239 B + QDC 239.5

PUM 0.8/3.2-700 bar

The mobile high-pressure power unit manages 700 bar: a real magic box!

UNIFLEX mobile hydraulic power packs are popular worldwide due to their high performance, robustness and compact dimensions. worldwide. With an innovative high-pressure power unit, UNIFLEX now offers a practical accessory, namely an ingeniously simple external power tool: with a standard cordless screwdriver (min. 25 Nm drive torque), manual workshop presses for 1" hoses (4SH/R15) can be driven hydraulically.



PUU

The PUU is a hydraulic unit with an oil delivery capacity of 10 l/min at 28 MPa/280 bar.

This compact system with integrated 35 l oil tank fits perfectly with our HM 200 or can be used flexibly in other ways.



Technische Daten	PUM	PUU
Max. pressure	70 MPa (700 bar)	28 MPa (280 bar)
Nominal pressure	70 MPa (700 bar)	28 MPa (280 bar)
Adjustable pressure relief valve	up to 700 bar manually adjustable	-
Drive	All commercially available cordless screwdrivers (min. 25Nm)	1-3 phases 2,2-3 KW
Temperature range	10°C to +35°C	-
Shoulder strap	✓	-
Oil tank volume	2,5 l	35 l (Ölvolumen)
Pressure gauge measuring connection	✓	-
Delivery rate	3.2 L/min Low pressure up to 5 MPa (50 bar) 0.8 L/min High pressure above 5 MPa (50 bar)	10 l/min (max.)
L x W x H (mm)	245 x 170 x 220	300 x 450 x 550
Weight	8.5 kg with oil	33 kg